

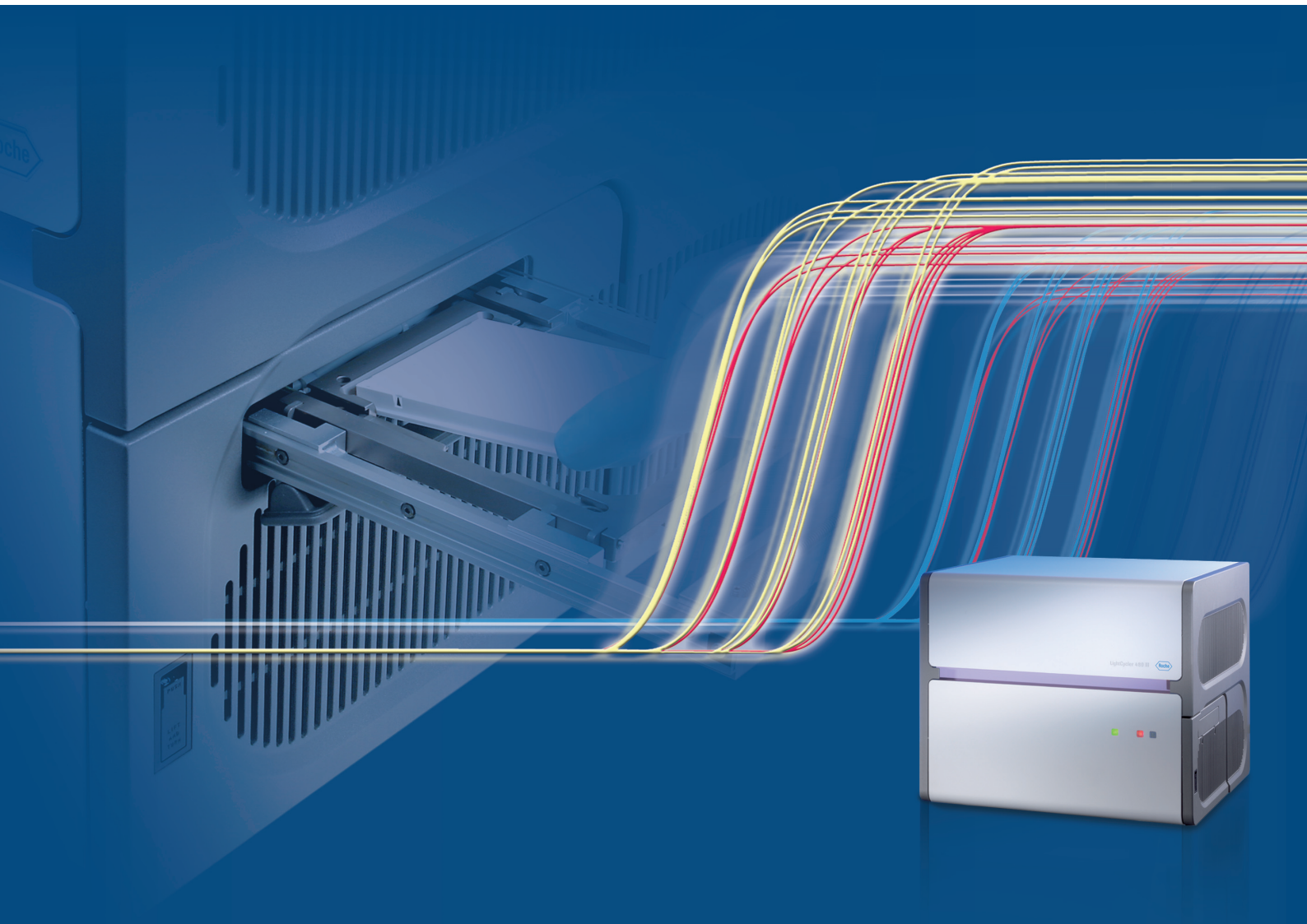

LightCycler®

The LightCycler® 480 System
Unleash the Potential of Real-Time PCR



Amplify your success in medium- and high-throughput real-time PCR applications with the renowned LightCycler® 480 System from Roche Applied Science.

The LightCycler® 480 System is a plate-based, highly adaptable and versatile real-time PCR system for gene expression analysis, SNP genotyping, and mutation scanning via high resolution melting (HRM).

The modern instrument design, outstanding technical features, and comprehensive software make the LightCycler® 480 System your platform of choice for high speed and accuracy in all current real-time PCR applications.

The LightCycler® 480 Real-Time PCR System	3
Introduction	3
System Components	5
Instrument Description	5
Software	7
Reagents and Disposables	8
System Applications	10
Performance Data	10
Custom RT-qPCR Assays and Panels	11
RealTime ready Cell Lysis Kit	12
LightCycler® 480 Gene Quantification Solutions	13
LightCycler® 480 Genotyping Solution	14
LightCycler® Gene Scanning Solutions	15
Automatic Workflow Integration	16
The LightCycler® 480 Service Concept	17
LightCycler® 480 Instrument Specifications	18
Ordering Information	19

For life science research only. Not for use in diagnostic procedures.

The LightCycler® 480 Real-Time PCR System

A standard for high-performance real-time PCR

Take your real-time PCR projects to outstanding levels of sensitivity, specificity, and throughput with the accuracy, versatility, and speed of the LightCycler® 480 System.

Compelling reasons for choosing the LightCycler® 480 System

- Unique thermal block cycler technology for exceptional well-to-well data homogeneity.
- Advanced optical system for robust and accurate capturing of all data simultaneously without scanning.
- Easily interchangeable 96- and 384-well thermal block cycler units.
- Optional clear or white plates, depending on your workflow and sensitivity needs.
- Excellent PCR sensitivity with high-value LightCycler® 480 reagents and disposables.
- High flexibility with fluorescence dyes and detection formats.
- Basic and advanced gene expression and genetic variation analysis.
- Genetic variation studies based on HybProbe and/or SimpleProbe Probes, high resolution melting or endpoint genotyping.
- Pre-plated, function-tested RealTime ready Assays, available as catalog or custom panels and single assays.
- Intuitive, user-friendly LightCycler® 480 Software interface.
- Fast and easy assay setup with the new sample editor.
- One-click experiment setup with options to refine results later.
- Multi-function database with research and traceable modes.
- State-of-the-art LIMS connectivity.
- 21 CFR part 11 compliant data protection.
- Premium customer support and instrument service.



The LightCycler® 480 Real-Time PCR System

Proven, high performance technology

For more than a decade, the LightCycler® Real-Time PCR Systems from Roche Applied Science have stood for flexibility, high speed, and outstanding data accuracy. The LightCycler® 480 System represents the apex of the LightCycler® series, offering a comprehensive, high-end qPCR solution for the modern genomics research lab.

Innovative technological enhancements in the LightCycler® 480 Instrument pave the way for new standards of rapid and accurate plate-based real-time PCR data generation and analysis. The sophisticated design of the silver thermal block cycler unit, calibration-free optical system, and versatile software deliver the sensitivity, accuracy, and reproducibility one has come to expect from Roche instruments.

For enhanced flexibility, many components of the LightCycler® 480 Instrument are modular in design. This setup enables users to easily interchange thermal block cyclers (96- and 384-well format), combine various optical filters, and choose between clear or white multiwell plates.

The system can be seamlessly integrated into computer-controlled environments and automated workflows. This system setup facilitates data management that complies with 21 CFR Part 11 requirements.

The LightCycler® 480 System comprises versatile instrumentation and software as well as high-performance reagents, customized qPCR assays (see p. 11) and specially engineered disposable products. This innovative system meets the tough demands of qualitative target detection, quantitative gene expression, and mutation analysis. In addition, its built-in versatility facilitates easy adaptation to new technologies in genomic research.

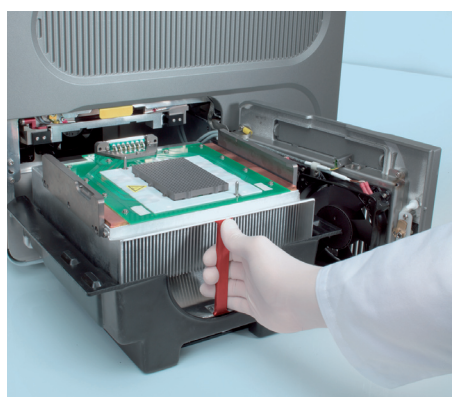

Figure 1: Flexibility of the LightCycler® 480 Block Cycler unit. The LightCycler® 480 Block Cycler units (96-well/ 384-well format) are easily interchangeable by the user, taking only a few minutes. The exchanged block cycler unit is automatically detected and identified by the system, and experiments can proceed without time-consuming recalibration runs.

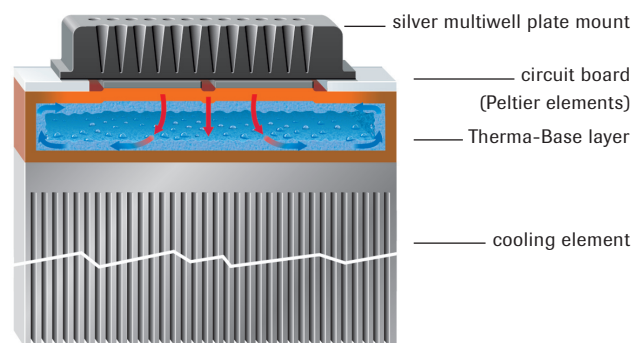

Figure 2: Schematic of the LightCycler® 480 Thermal Block Cycler. The Therma-Base layer, implemented in the block cycler unit architecture, is a thin cavity lined with a wick structure and filled with fluid. Utilizing a series of condensation and evaporation events, the Therma-Base rapidly adjusts to temperature changes by efficiently dissipating heat.

The LightCycler® 480 Instrument

A superb combination of speed, accuracy, and versatility

Innovative PCR thermal block cycler design

The LightCycler® 480 System has revolutionized block cycler temperature control through the introduction of a highly efficient heat-equalizing technology (Therma-Base) between the heat block and the cooling element. By removing the effects of spreading resistance, the LightCycler® 480 thermal block cycler provides outstanding well-to-well temperature homogeneity (see Figures 3 and 4). The precise temperature control enables exceptional data uniformity, independent of assay formats or real-time PCR applications, even in fast PCR protocols.

Key benefits of the LightCycler® 480 Thermal Block Cycler:

- Run any assay format or application with fast PCR protocols (< 40 minutes for 40 cycles in 384-well plate format).
- Obtain rapid and accurate temperature adjustment.
- Achieve exceptional data homogeneity across the entire multiwell plate.

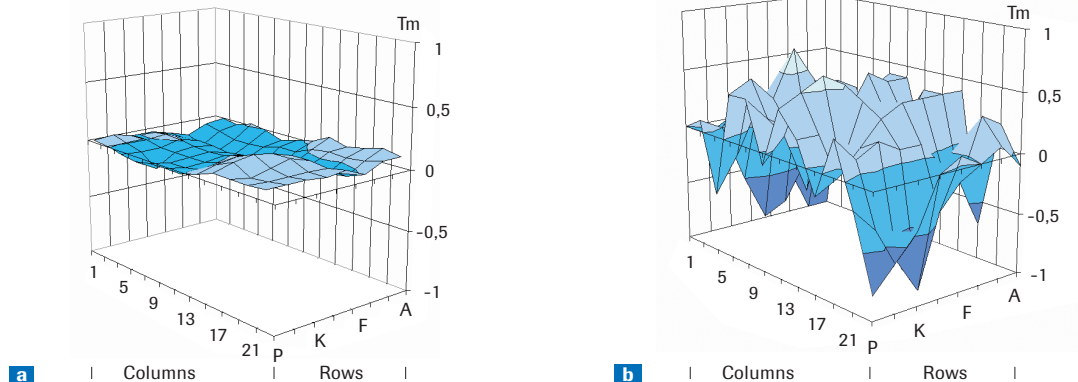

Figure 3: Temperature homogeneity across a 384-well plate: a) LightCycler® 480 Instrument; b) another real-time PCR instrument. The melting temperature (T_m) of a given labeled oligonucleotide was used to demonstrate temperature homogeneity

across a multiwell plate (at 50°C). The variation between the measured T_m and the expected T_m of the oligonucleotide was plotted for all 384 wells using the expected T_m as zero.

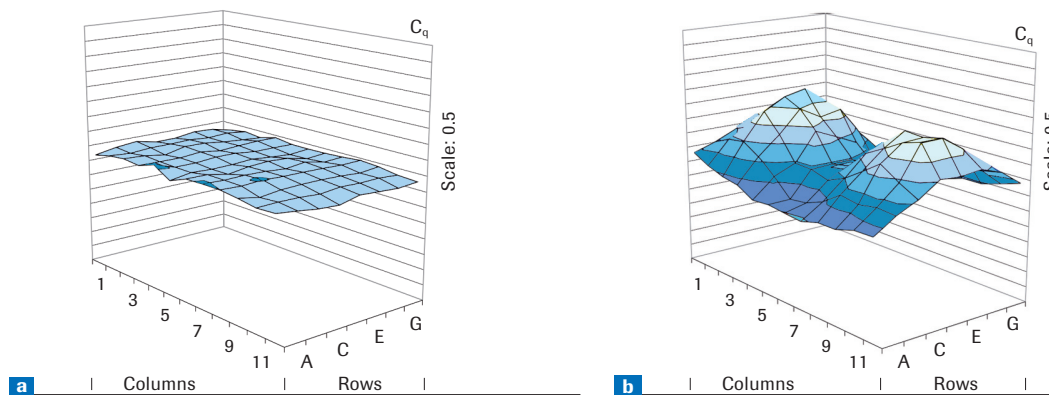

Figure 4: Crossing point (C_q) homogeneity across a 96-well plate: a) LightCycler® 480 Instrument; b) another real-time PCR instrument. A low target concentration (100 copies) of a

given target sequence (442 bp) was amplified using a fast PCR protocol (20 μ l reaction volume, hydrolysis probe format). C_q values were plotted for all 96 wells using a 0.5-step C_q scale resolution.

The LightCycler® 480 Instrument

An ideal combination of speed, accuracy, and versatility

Advanced high-performance optical system

The LightCycler® 480 Instrument's optical system features a high-intensity LED which emits light across a broad spectrum. A flexible combination of built-in filters for specific excitation and emission facilitates the use of a variety of fluorescent dyes and detection formats for any current real-time PCR application (see Table 1).

The special arrangement of the optical components and the optimum focal length in the LightCycler® 480 Instrument ensure excellent specific signal excitation and uniform data capturing across the entire multiwell plate, independent of sample position. Together with excellent signal acquisition rates, this also allows melting curve analysis at high resolution. It also eliminates the need for passive reference dyes (*e.g.*, ROX) for well-to-well signal normalization. As a result, the LightCycler® 480 System gives you the added flexibility to use all channels for target detection, extending multiplexing capabilities.

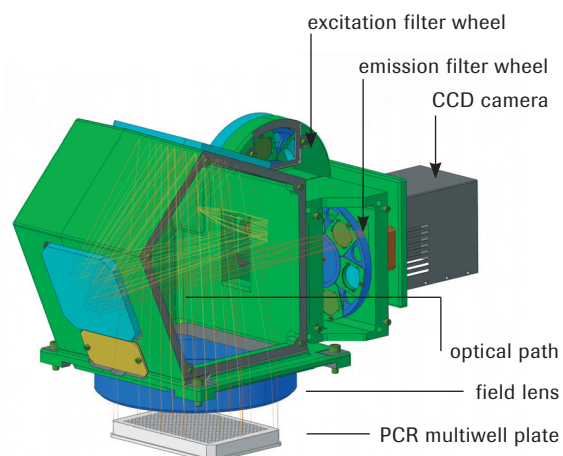

Figure 5: Schematic of the LightCycler® 480 Detection Unit.

Key benefits of the LightCycler® 480 Optical System:

- Capture all data simultaneously for a whole plate without the need to scan, avoiding inconsistencies and mechanical instability.
- Enjoy highest flexibility in the choice of fluorescence dyes and detection formats.
- Get advanced accurate data capture across the entire plate without fluorescence signal normalization.
- Work with enhanced multiplexing capabilities.*
- Easily access commonly used channel combinations via pre-defined settings.

Table 1: Overview of excitation and emission filters, dyes and detection formats. The LightCycler® 480 Instrument employs a high-intensity LED that emits light over a broad wavelength range (390–710 nm). The five excitation and six emission filters of the instrument can be used in any combination.

LED (390 – 710 nm)								
Excitation filters	440	465	498	533			618	
Emission filters	488	510	580	610	640	660		
Dye	LightCycler® Cyan 500	SYBR Green I ResoLight	Fluorescein FAM	HEX (VIC)	LightCycler® Red 610	LightCycler® Red 640	Cy5	
Detection formats	Melting Curve	•						
	HRM	•						
	SimpleProbe probes		•					
	HybProbe probes			*		•	•	
	Hydrolysis probes 1–3 colors			•	•			•
	Hydrolysis probes 4 colors	•		•		•		•

*FRET Donor

*See for example: Richard Molenkamp *et al.*, (2007). Journal of Virological Methods, Volume 141, Issue 2, Pages 205-211.

The LightCycler® 480 Software

Advanced tools to generate high quality data

High-value software capabilities

The LightCycler® 480 Software is characterized by state-of-the-art design and unique algorithms for fast, highly accurate data generation, without sacrificing comprehensive versatility. Customizable views facilitate intuitive navigation, and a highly sophisticated sample editor allows easy programming, data capturing, and analysis. Convenient import and export functionalities enable the seamless integration of the LightCycler® 480 Instrument into computer-controlled environments. Additionally, modern data management and effective data protection capabilities are implemented in the software.

The LightCycler® 480 Software provides versatile solutions for the most common real-time PCR applications. The pre-installed software package comprises automated analysis modules for melting curve or endpoint-based genotyping as well as absolute and relative quantification. Additional software modules are available for high resolution melting and multiple plate analysis.

Thus, the LightCycler® 480 System meets all your research needs, from comprehensive customized scientific approaches to streamlined automated routine workflows.

Key benefits of the LightCycler® 480 Software:

- Quickly start experiments from ready-to-use macros or templates for all applications.
- Apply basic or advanced analysis modes for both gene expression and genotyping studies.
- Conveniently define or edit sample information in plate or table views.
- Choose between a flexible research mode or a secured traceable database mode.
- Benefit from high-end reporting tools to generate separate documentation for each analysis.

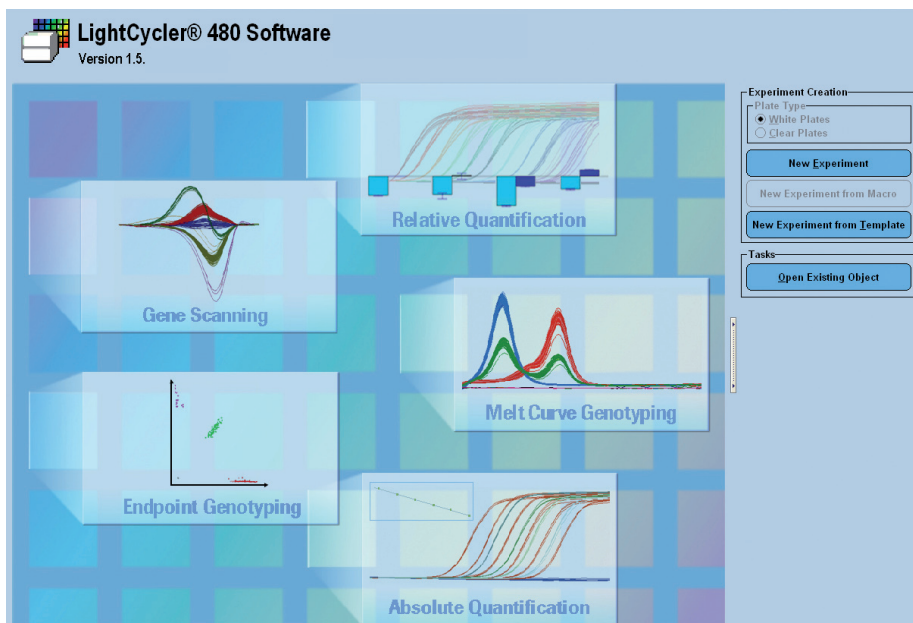

Figure 6: Screenshot of the LightCycler® 480 Software interface (opening screen):

- Gain easy access to a broad range of quantification and genotyping methods.
- Quickly start new experiments from macros or templates.

LightCycler® 480 Reagents and Disposables

Maximized convenience in fast real-time PCR

High-performance reagents for all PCR application needs

LightCycler® 480 Reagents are based on Roche Applied Science's improved hot-start PCR enzyme formulation. The ready-to-use LightCycler® 480 Master Mixes are specially designed to support each of the main real-time PCR applications (e.g., gene quantification, genotyping) for both standard and fast ramping PCR run protocols.

Key benefits of the LightCycler® 480 Reagents:

- Enjoy exceptional detection sensitivity and specificity for all standard and fast PCR protocols.
- Get maximum enzyme stability for automated high-throughput workflows at room temperature.
- Save time with ready-to-use one-component master mixes.

Furthermore, these optimized master mixes offer extended room temperature stability for maximum robustness on automated high-throughput workflows, and improved storage conditions for added convenience with daily use (see Figure 7).

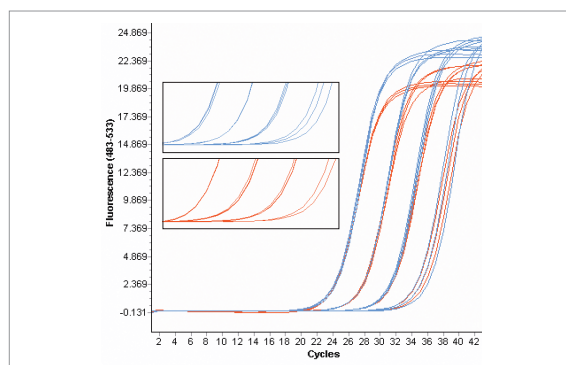

Figure 7: Stability of the LightCycler® 480 SYBR Green I Master. Serial 1:10 dilutions (10,000 – 10 copies/reaction, three replicates) of a human DNA target sequence were assayed either immediately after PCR setup (blue curves) or after 24 hours standing in a loading robot at room temperature (red curves). The shape of the amplification curves demonstrates that the PCR performance was not affected by prolonged pre-PCR standing.

Analysis of	Reagent	Formats	Applications
DNA	LightCycler® 480 SYBR Green I Master (2× concentrated)	SYBR Green I	Qualitative/ Quantitative
	LightCycler® 480 High Resolution Melting Master (2× concentrated)	ResoLight dye	Qualitative/ Quantitative
	LightCycler® 480 Genotyping Master (5× concentrated)	HybProbe probes, SimpleProbe probes	Melting curve-based genotyping*
	LightCycler® 480 Probes Master (2× concentrated)	Hydrolysis probes, UPL probes, RealTime ready assays, HybProbe probes, SimpleProbe probes	Qualitative/ Quantitative
RNA	LightCycler® 480 RNA Master Hydrolysis Probes	Hydrolysis probes, UPL probes	One-Step qRT-PCR

Table 2: Application areas of the LightCycler® 480 Reagents. All LightCycler® 480 Reagents prevent carryover contamination by employing dUTP for UNG (uracil-DNA-glycosylase)-mediated decontamination. Extended storage conditions enable storage at +4 to +8°C for up to four weeks, in addition to the usual long-term storage conditions at -15 to -25°C.

* Optimized for multiplex applications. Not suitable for end-point genotyping with hydrolysis probes because enzyme lacks 5'-exonuclease activity.

- Sequence-independent DNA detection
- Sequence-specific DNA detection



Optimized disposables

Specially designed LightCycler® 480 Multiwell Plates fit perfectly in the thermal block cycler mount, ensuring maximum heat transfer and therefore maximum PCR sensitivity and reproducibility. The opaque, white-colored plate design provides excellent optical sensitivity. These plates ensure consistent PCR results without the need for routine decontamination of the thermal block cycler mount (*e.g.*, removal of fluorescence-labeled probes). Clear LightCycler® 480 Multiwell Plates are available as an alternative for SYBR Green I and hydrolysis probe assays on instruments with LightCycler® 480 Software, Version 1.5 installed. Bar codes on each plate enable simple and user-friendly workflow tracking.

Key benefits of LightCycler® 480 Multiwell Plates:

- Achieve high PCR sensitivity and reproducibility with the specialized plate design.
- Eliminate the risk of false-positive influences in PCR results.
- Benefit from bar code-labeled multiwell plates for fast workflow tracking.
- Choose from clear and white plates, depending on your workflow and sensitivity needs.

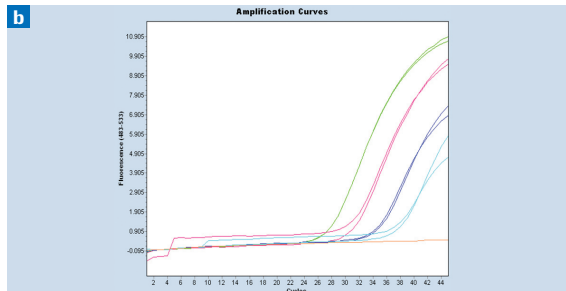
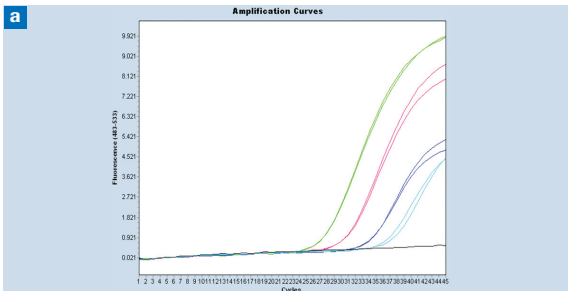

Step	Temp. °C	Time (a)	Time (b)	Cycles
Reverse transcription	63	3 min	3 min	1
Denaturation	95	30 sec	30 sec	1
Denaturation	95	10 sec	1 sec	45
Annealing	60	30 sec	10 sec	
Elongation	72	1 sec	1 sec	

Table 3: One-step RT-PCR assay with the fast cycling protocol using the LightCycler® 480 RNA Master Hydrolysis Probes.

Dilutions of total RNA (DNA-free) from HeLa cells (from 100 pg to 0.1 pg) were amplified in duplicate in 96-well plates in a total volume of 20 µl and detected with a Universal ProbeLibrary assay for beta-actin. Addition of the special enhancer solution generated equivalent crossing point values with the conventional protocol **a)** and the fast protocol **b)**.

Ultra-fast and sensitive RNA analysis

For one-step RT-PCR with hydrolysis probe detection, the LightCycler® 480 System includes a master mix that is specially adapted to the rapid and accurate cycling environment of the LightCycler® 480 Instrument. Optimized buffers maintain sensitivity while allowing significantly shorter reverse transcription than with traditional methods.

Highly accurate qPCR data can thus be generated in less than 45 minutes. Multiplex assays can be set up to analyze target and reference genes together, or to study several DNA or RNA viruses in a single well. The LightCycler® 480 RNA Master is also an ideal companion for Universal ProbeLibrary probes when assays have to be designed quickly and results are needed fast.

LightCycler® 480 System Performance

Excellent dynamic range, sensitivity, and reproducibility

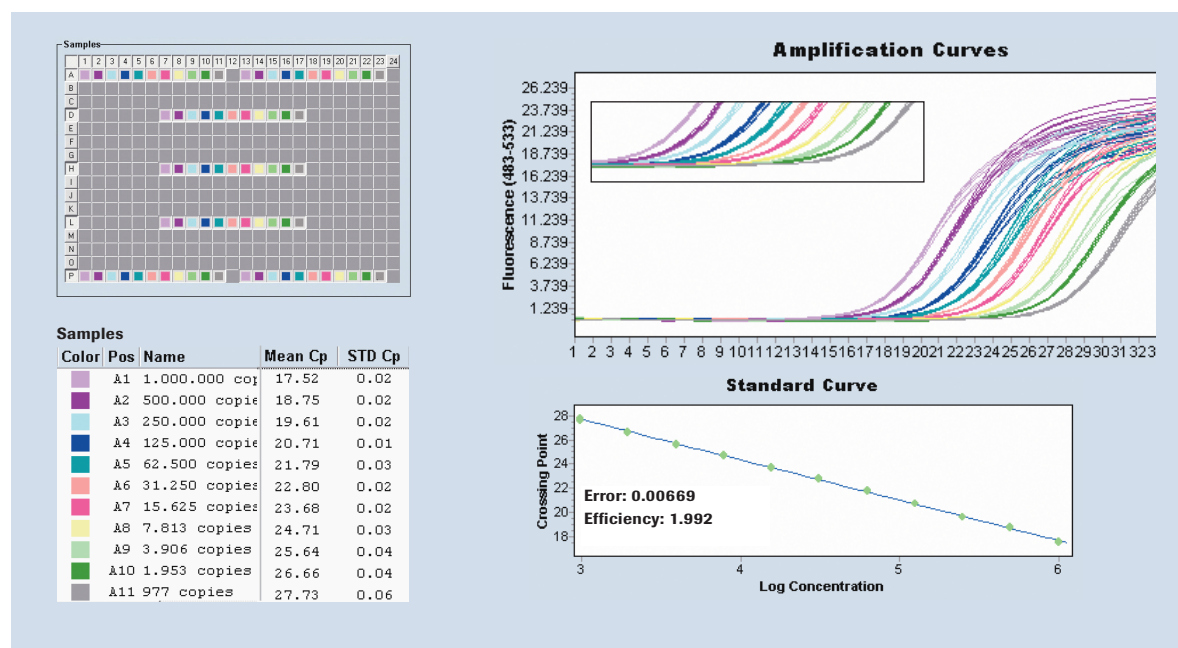
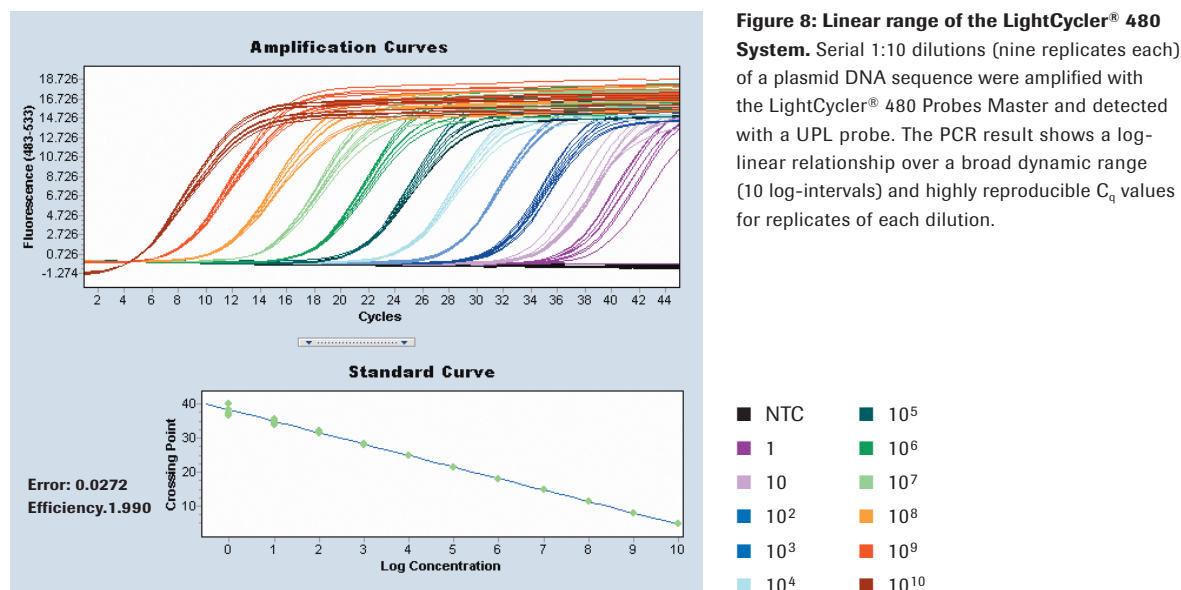

Figure 9: Sensitivity and reproducibility of the LightCycler® 480 System. Serial 1:2 dilutions (seven replicates each) of a viral target sequence were assayed with the LightCycler® 480 SYBR Green I Master. A special pipetting scheme was used to distribute the samples across the entire plate.

Results obtained from every position demonstrate the outstanding resolution, sensitivity, reproducibility, and data homogeneity of the LightCycler® 480 System. Reproducibility is shown by the uniformity of C_q values within replicate groups and low coefficients of variation ($CV < 0.2\%$).

Custom RT-qPCR Assays and Panels

Designed and uniquely function tested to meet your needs

Probe-based, but as flexible as SYBR Green

Fast and accurate gene expression analysis can be achieved with the integration of the LightCycler® 480 System, advanced RT-PCR reagents (e.g., Transcriptor First Strand cDNA Synthesis Kit) and the highly flexible Universal ProbeLibrary qPCR assays. The unique combination of pre-tested Universal ProbeLibrary (UPL) real-time PCR probes and a free, online assay design service (**www.universalprobelibrary.com**) allows rapid and flexible quantification of virtually any transcript in the transcriptomes of a large number of organisms (see Figure 10).

Convenience in design, confidence in performance

UPL qPCR assays enhance throughput and efficiency without compromising on sensitivity and specificity. Quantifying the expression of any human gene of interest is easy using an endogenous control in a dual-color assay. In addition to the 165 FAM-labeled Universal ProbeLibrary probes, assays for four human reference genes are available. The assays contain primers and UPL probes, labeled with LightCycler® Yellow 555 and a dark quencher, specific for the respective reference gene.

ProbeFinder has designed the optimal real-time PCR assay for:
[ENST00000265986.3](#)[|](#)[ENSG00000119912.4](#) IDE_HUMAN Uniprot./SWISSPROT
 Insulin-degrading enzyme (EC 3.4.24.56) (Insulysin) (Insulinase) (Insulin protease).
 [Source:Uniprot/SWISSPROT;Acc:P14735]

Assay details: Use Universal ProbeLibrary probe: #24, cat. no. 04686985001

Primer	Length	Position	Tm	%GC	Sequence
Left Primer	21	2324 - 2344	59	52	aacctctcttccaagtcagc
Right Primer	22	2380 - 2401	59	41	tctgtgataaaccaaacatcc

Amplicon (78 nt)

```
aacctctcttccaagtcagctgggttcggtatagagaagtccaagctccctgacagaggat
ggtttggttatcagcaga
```

Key benefits of the Universal ProbeLibrary System:

- Significantly reduce the assay design time for any target.
- Enjoy excellent flexibility, specificity, and convenience.
- Simplify multitarget analysis and dual color assays with the UPL standard PCR protocol.

Figure 10: The free, online ProbeFinder service provides detailed information about recommended primers for a specific assay, and the resulting amplicon detected by the respective pre-tested UPL probe.

UPL probes combined with primers are also available as ready-to-use, function tested, custom single assays or panels (RealTime ready Assays). They can be easily designed and ordered via an online configuration portal (see Figure 11 and www.realtimeready.roche.com for more information) and are delivered pre-plated and dried-down in either 96- or 384-well plates. Reference genes and error-checking wells to test initial RNA quality, RT efficiency, and presence of residual genomic DNA are also included.

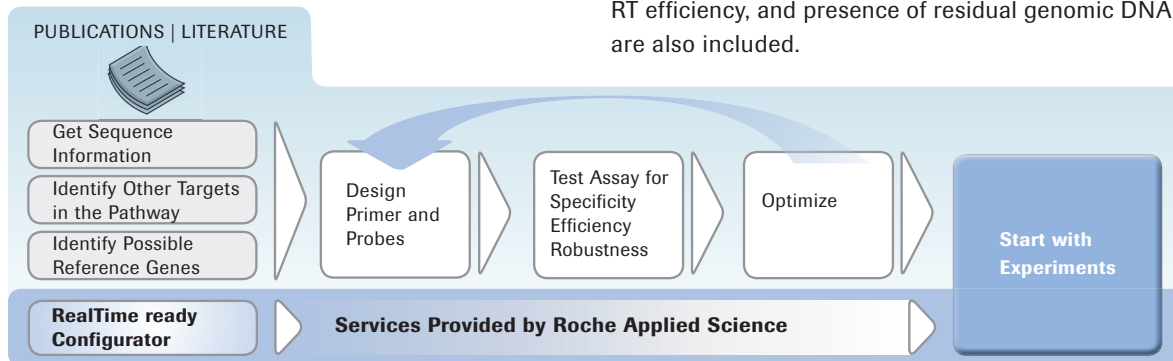

Figure 11: RealTime ready Assay design and delivery workflow.

RealTime ready Cell Lysis Kit

Fast one-step cell lysis for RT-qPCR

Experience fast gene expression analysis directly from cells

- **Replace multi-step RNA purification:** Lyse cells directly in a single step for direct use in cDNA synthesis followed by real-time PCR.
- **Increase convenience:** Use a simple one-step cell lysis for PCR, without extra steps.
- **Faster time to results:** Lyse samples in just 5 minutes at room temperature (+15 to +25°C).
- **Reduce intermediate steps:** Simply perform the DNase treatment during the cDNA synthesis incubation.
- **Benefit from broad applicability:** Scale up from 3 to 30,000 cultured cells in all available multiwell formats, including automation options.

Total qPCR workflow results in just 75 minutes...

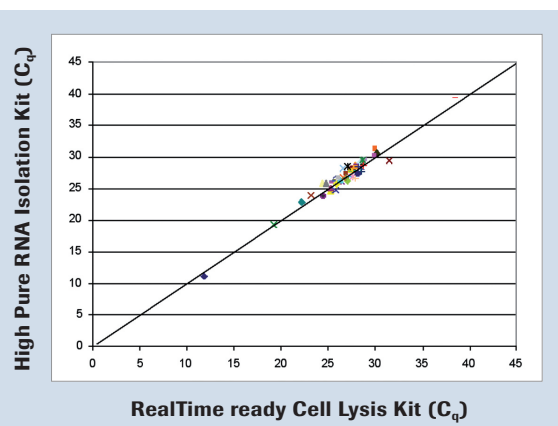

Figure 12: Real-time PCR results using a fast-track workflow with the RealTime ready Cell Lysis Kit, in comparison to the standard workflow with the column-based High Pure RNA Isolation Kit. Real-time PCR findings show accurate, reproducible results for both RNA isolation methods, resulting in high correlation of quantification cycles (C_q values) for the 19 different reference genes tested.

Experimental setup: 30,000 HeLa cell equivalents/well were used for RNA preparation. RNA was reverse transcribed using the Transcriptor First Strand cDNA Synthesis Kit. Real-time PCR was performed on the LightCycler® 480 Instrument (96-well format, 20 µl reaction), using the LightCycler® 480 Probes Master and RealTime ready Human Reference Gene Panel.

LightCycler® 480 Gene Quantification Solutions

Practical solutions for gene expression studies

Versatile solutions for gene quantification

The LightCycler® 480 Software provides multiple solutions for quantitative real-time PCR (qPCR) analyses. Absolute and relative quantification analysis methods and subtypes of these techniques are implemented in the LightCycler® 480 Software. Based on unique LightCycler® System algorithms, the LightCycler® 480 Quantification Software provides access to reliable data, allowing users to choose from basic or advanced analysis methods.

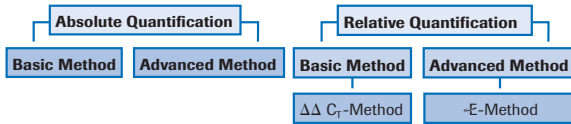

Figure 13: Overview of the different PCR quantification principles.

Key benefits of the LightCycler® 480 Quantification Software:

- Speed up PCR analysis with user-friendly, fast-tracking software tools.
- Choose from quick one-click data checks and in-depth refined analyses for each PCR result; analyze your data the way you want to.
- Get fast results by using basic PCR efficiency assumptions, or achieve ultimate data accuracy with standard-curve derived efficiencies.
- Use one or several targets and/or reference genes.
- Analyze targets and references present on same or different plates.
- Choose between Fit Points Method or Second Derivative Maximum Method for C_q calling.

Peak performance for gene expression analysis

The LightCycler® 480 Relative Quantification Software provides different relative quantification methods (e.g., basic $\Delta\Delta C_T$ -Method, advanced E-Method with standard-curve derived efficiencies) for gene expression and gene dosage studies.

This versatility offers you various degrees of quantification reliabilities adaptable to your individual experiment needs. One single PCR result can be refined by guiding it through the different analysis methods.

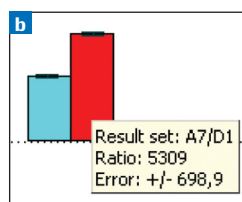
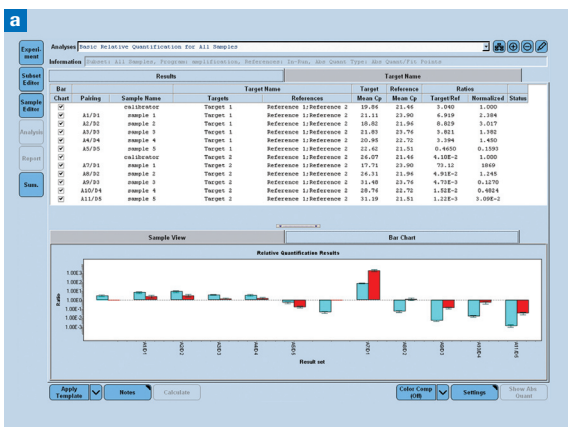

Figure 14: Advanced relative quantification analysis (-E-method). (a) Upper part: results in table view, including sample information on chosen references, pairing, and C_q values. Lower part: Bar-chart display (including errors) of target/reference ratios, with normalized values in red. (b) Exact values can be read easily using the mouse-over function.

LightCycler® 480 Genotyping Solutions

Reliable methods for genetic variation research

Easy access to comprehensive and accurate genotyping information

Genotyping (SNP analysis) on the LightCycler® 480 System can be performed based on two different methods: melting curve analysis with HybProbe Probes or SimpleProbe Probes (using the LightCycler® 480 Genotyping Master), and endpoint analysis with hydrolysis probes (using the LightCycler® 480 Probes Master). For both methods, software modules for fully automated analysis are included in the preinstalled LightCycler® 480 Software, Version 1.5. In melting curve analysis, different alleles or allele combinations are identified due to the different strength of interaction they have with the probe. Allele-specific primers or probes are not needed; the same sequence is used for all alleles of an investigated SNP. This reduces reagent costs and enables straightforward reaction multiplexing. As a post-PCR process, melting curve analysis depends neither on the efficiency of the amplification process

nor on the cleavage of a substrate, and is therefore very robust. The LightCycler® 480 System genotyping algorithm groups samples with similar melting curve shape either by auto-calling or via included standards of known genotypes (see Figure 15a).

Endpoint genotyping is based on the use of dual color hydrolysis probe assays with (for example) commercially available predefined SNP genotyping assays. Genotypes can be called automatically and easily visualized in scatter plots (see Figure 15b).

Key benefits of LightCycler® 480 Genotyping Solutions:

- Choose between HybProbe-/SimpleProbe probes or hydrolysis probe based methods.
- Perform endpoint genotyping to set up experiments quickly without optimization.
- Get more insight into complex genetic setups by running highly flexible melting curve assays.

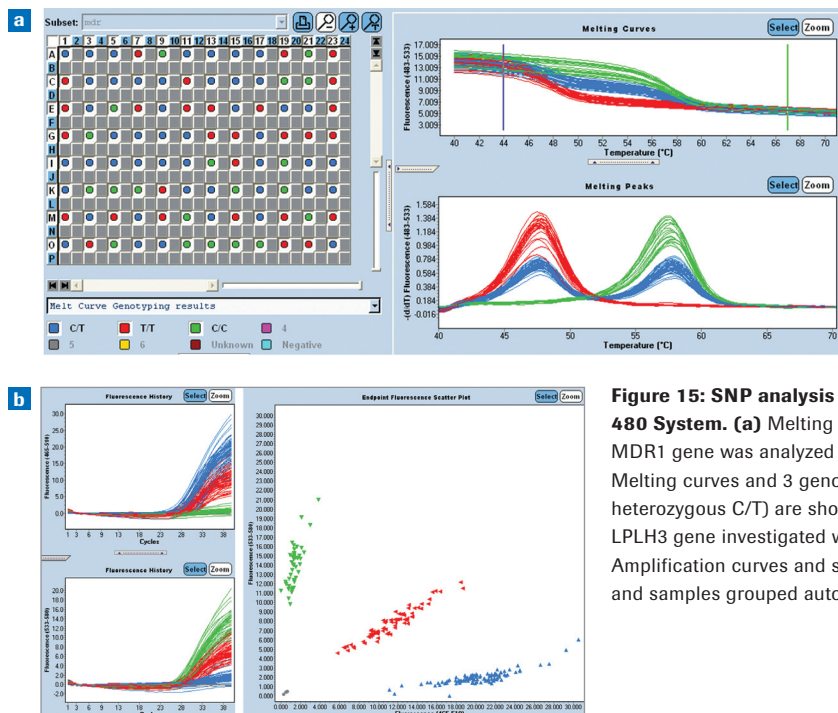

Figure 15: SNP analysis methods on the LightCycler® 480 System. (a) Melting curve analysis: A polymorphism in the MDR1 gene was analyzed with SimpleProbe Probes. Melting curves and 3 genotypes (homozygous C/C and T/T, heterozygous C/T) are shown. **(b)** Endpoint analysis of the LPL3 gene investigated with hydrolysis probes. Amplification curves and scatter plot analyses can be displayed and samples grouped automatically.

LightCycler® 480 Gene Scanning Solutions

A proven standard for high resolution melting

Sensitive mutation discovery

High Resolution Melting is a homogeneous, closed-tube, post-PCR technique enabling researchers to rapidly and efficiently discover genetic variations (e.g., SNPs, indels, methylations) in DNA fragments. High Resolution Melting provides outstanding specificity and sensitivity with high sample throughput. It also saves time and reduces costs compared to non-homogeneous (gradient- or gel-based) mutation screening methods (e.g., dHPLC) that require PCR and analysis on separate instruments.

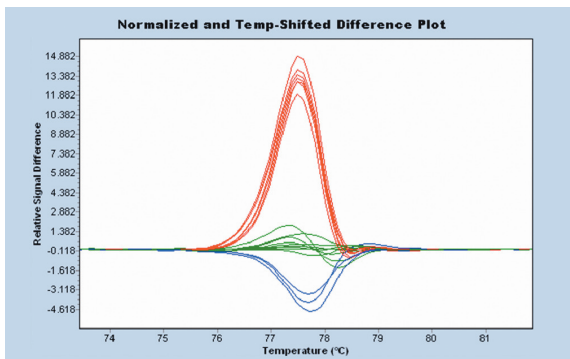

Figure 16: LightCycler® 480 Gene Scanning Software reveals differences between wild types and variants by grouping of HRM curves. A fragment of the human TNF SF18 gene with the A/T polymorphism rs723858 was amplified by PCR using the LightCycler® 480 High Resolution Melting Master from genomic DNA isolated from research blood samples. Difference curve analysis enables differentiation between wild type samples (AA, green), homozygous mutants (TT, blue), and heterozygotes (AT, red.).

In a LightCycler® 480 Gene Scanning experiment, sample DNA is first amplified in the presence of ResoLight, a novel type of saturating DNA dye contained in the LightCycler® 480 High Resolution Melting Master. Using the instrument's high data acquisition rate, a melting curve is generated, and the resulting data analyzed using the optional LightCycler® 480 Gene Scanning Software Module.

In this analysis, signal differences between each curve and one chosen reference curve are plotted, allowing the automatic clustering of samples into distinct groups that have similar melting curve shapes (e.g., heterozygotes versus homozygotes).

Key benefits of the LightCycler® 480 Gene Scanning Solution:

- Special PCR master includes novel High Resolution Melting dye with improved signal dynamics and PCR compatibility.
- Automated grouping algorithm efficiently identifies new variants with high sensitivity.
- Reliable detection of single-base variants – including class IV SNPs (see Figure 16).

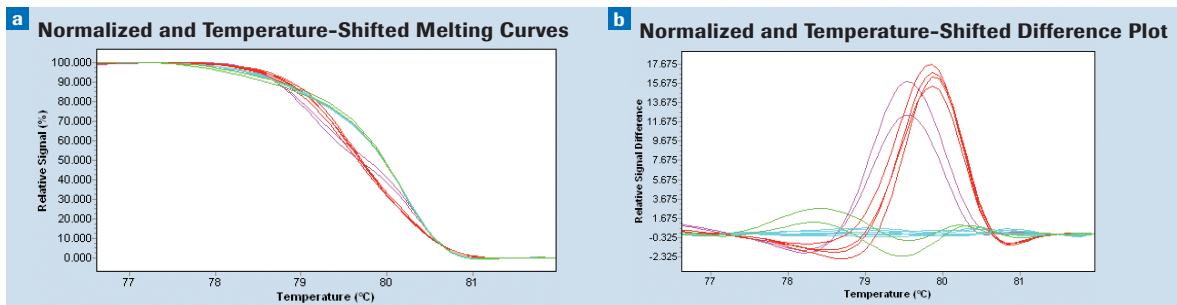

Figure 17: Genetic variation in the human CFTR gene analyzed by high resolution melting. a) A 198 bp fragment of the human CFTR gene was amplified using the LightCycler® 480 High Resolution Melting Master and subjected to amplicon melting at high resolution. b) Difference plot analysis revealed three different groups of heterozygotes (red, pink, and green) in addition to the homozygous samples (blue). Data courtesy of Dr. Peter Bauer and Dr. Stefanie Beck-Wödl, University Hospital of Tübingen, Germany.

LightCycler® 480 Workflow Integration

Automated high-throughput solutions

True workflow capabilities

The LightCycler® 480 System can be seamlessly integrated into a computer-controlled environment or automated laboratory workflow with the optional LightCycler® 480 LIMS Interface module. This module facilitates two-way information exchange between the LightCycler® 480 System and a Laboratory Information Management System (LIMS).

Furthermore, this module can control system loading procedures, the PCR run, and data analysis, thereby enabling integration of the LightCycler® 480 System into a completely automated workflow. The ability to recognize bar code-labeled LightCycler® 480 Multiwell Plates (via the internal bar code reader) is pre-installed on all LightCycler® 480 Instruments with Software Version 1.5.

Dependable data management

The LightCycler® 480 System is compliant with 21 CFR Part 11, and meets the general regulatory data management requirements.

Sample preparation solutions

The LightCycler® 480 System is easily combined with Roche automated solutions for nucleic acid isolation and purification, including the versatile MagNA Pure Compact and MagNA Pure LC 2.0 Systems, as well as the MagNA Pure 96 System, able to purify up to 96 samples in less than an hour (see Figure 18 and www.magnapure96.roche.com).

Key benefits of the LightCycler® 480 System workflow capabilities:

- Benefit from true walk-away and automation workflow capabilities.
- Enjoy easy LIMS connectivity.
- Ensure regulatory data management requirements.
- Combine the LightCycler® 480 Instrument and the MagNA Pure 96 System to form a high performance sample preparation/qPCR workflow.

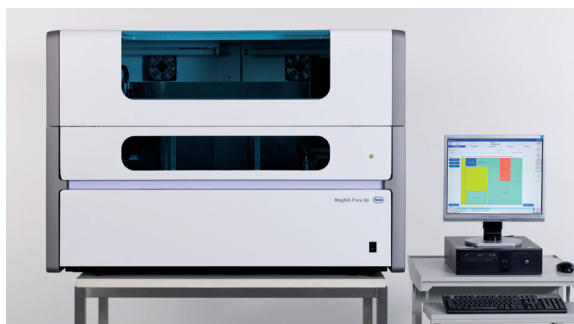

Figure 18: The MagNA Pure 96 System, enabling the isolation of high-quality DNA or RNA from up to 96 samples in less than one hour.

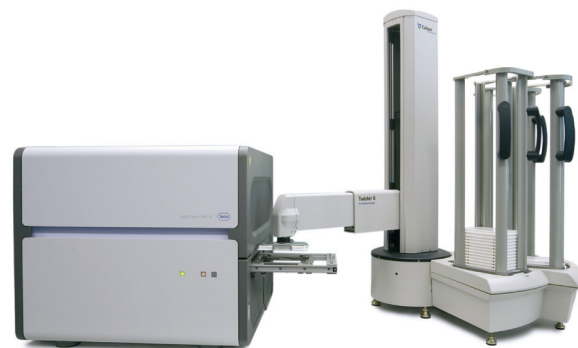

Figure 19: Automated LightCycler® 480 Instrument loading process.

The LightCycler® 480 Service Concept

All-points service you can trust

Roche Applied Science, part of Roche Diagnostics, can rely on 30 years success in laboratory instrumentation, and more than a decade of innovative development in real-time PCR instruments. Based on this vast expertise, we can offer a highly professional service concept that meets your demanding needs.

Modular design

The LightCycler® 480 Instrument's excellent modular design facilitates easy maintenance and optimal serviceability. In addition, the instrument has the added advantage that no routine maintenance is required (e.g., standard instrument calibration runs).

LightCycler® 480 System Services

Roche Applied Science is committed to providing innovative systems with highly professional service channels, worldwide. Furthermore, our ISO 13485 certified support organizations can offer you solutions to meet your specific needs.

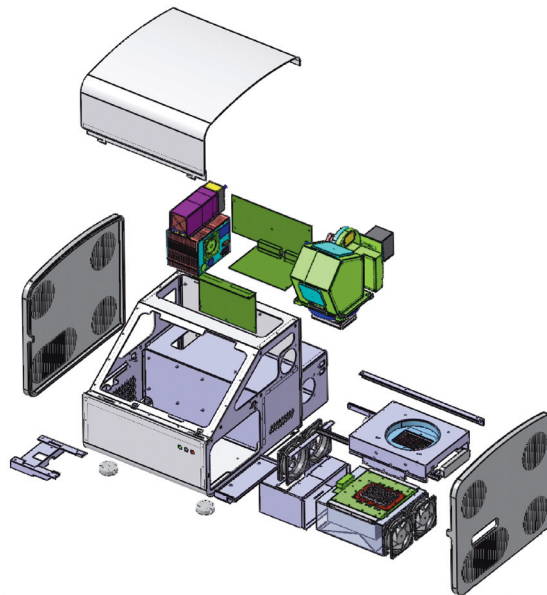

The LightCycler® 480 Service offers:

- Comprehensive LightCycler® 480 System online technical support
- Multi-language LightCycler® 480 System hotline.
- On-site LightCycler® 480 System technical support.
- Premium LightCycler® 480 Instrument IQOQ Qualification Service Package.^{1, 2)}
- Customized LightCycler® 480 System service plans and contracts.

¹⁾ The LightCycler® 480 Instrument Qualification Service Package consists of two service modules performed at your laboratory: IQ (Installation Qualification), OQ (Operational Qualification).

Furthermore, the service provides all the necessary documentation, including a detailed report.

²⁾ For further details on these optional services, please contact your local representative.

LightCycler® 480 Instrument Specifications

Dimensions	W 57.4 cm × D 58.8 cm × H 49.7 cm
Weight	55.6 kg
Block cycler unit	Easily interchangeable 96-/384-well format Includes Therma-Base
Reaction volumes	5 µl – 20 µl (384-well), 10 µl – 100 µl (96-well)
Temperature control	Peltier-based heating/cooling from 37°C – 95°C (20°C starting temperature to perform specific melting curve analyses)
Heating rate	96-well block: 4.4°C 384-well block: 4.8°C
Cooling rate	96-well block: 2.2°C 384-well block: 2.5°C
Excitation	Broad-spectrum, high-intensity LED (390 – 710 nm)
Detection	Simultaneous, scan-free detection of signals from all wells with telecentric optics and monochrome CCD camera
Filters	Excitation (nm): 440, 465, 498, 533, 618 Detection (nm): 488, 510, 580, 610, 640, 660
Computer	Pentium PC with Windows 7
Preinstalled software	<ul style="list-style-type: none"> • Tm Calling • Absolute Quantification Analysis • Relative Quantification Analysis • Endpoint Genotyping • Melting Curve Genotyping
Accessory software	<ul style="list-style-type: none"> • Gene Scanning Module for HRM Analysis
Automation	<ul style="list-style-type: none"> • Interface with LightCycler® 480 LIMS Interface Module • Barcode assisted multiwell plate scanning • Plate loading capability
Data management	21 CFR Part 11 compatibility
Maintenance and ROX calibration	not required

Order a LightCycler® 480 System, and additionally receive:

- On-site LightCycler® 480 System installation
- Customized LightCycler® 480 System startup training
- Comprehensive LightCycler® 480 Operator's Manual
- Expert LightCycler® 480 System user support

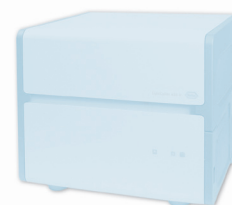

For life science research only. Not for use in diagnostic procedures.

LIGHTCYCLER, LC, REALTIME READY, MAGNA PURE, HIGH PURE, HYBPROBE, and SIMPLEPROBE are trademarks of Roche.

SYBR is a registered trademark of Life Technologies Corporation. PROBEFINDER, and PROBELIBRARY are registered trademarks of Exiqon A/S, Vedbaek, Denmark. All other product names and trademarks are the property of their respective owners.

Limited Label Licenses and Disclaimers

NOTICE: This product may be subject to certain use restrictions. Before using this product please refer to the Online Technical Support page (<http://technical-support.roche.com>) and search under the product number or the product name, whether this product is subject to a license disclaimer containing use restrictions.

Ordering Information

LightCycler® 480 Instruments and Accessories

Product	Cat. No.	Pack Size
LightCycler® 480 Instrument II, 96-well	05 015 278 001	1 Instrument ¹⁾
LightCycler® 480 Instrument II, 384-well	05 015 243 001	1 Instrument ¹⁾
LightCycler® 480 Block Kit 96 Silver	05 015 219 001	1 Kit ²⁾
LightCycler® 480 Block Kit 384 Silver	05 015 197 001	1 Kit ²⁾
LightCycler® 480 Bar-Code Scanner	04 710 606 001	1 Scanner
LightCycler® 480 Software, Version 1.5	04 994 884 001	1 Software Package
LightCycler® 480 LIMS Interface Module	05 066 310 001	1 Software Package
LightCycler® 480 Gene Scanning Software	05 103 908 001	1 Software Package
LightCycler® 480 Multiwell Plate 96, white	04 729 692 001	50 Plates / 50 Foils
LightCycler® 480 Multiwell Plate 384, white	04 729 749 001	50 Plates / 50 Foils
LightCycler® 480 Multiwell Plate 96, clear	05 102 413 001	50 Plates / 50 Foils
LightCycler® 480 Multiwell Plate 384, clear	05 102 430 001	50 Plates / 50 Foils
LightCycler® 480 Sealing Foil	04 729 757 001	50 Foils

¹⁾ Instrument package includes LightCycler® 480 Instrument, LightCycler® 480 Thermal Block Cycler unit (96- or 384-well), LightCycler® 480 Software, Version 1.5, LightCycler® 480 Instrument Operator's Manual. A Pentium desktop PC is supplied with the instrument.

²⁾ Kit package includes LightCycler® 480 Thermal Block Cycler unit (96- or 384-well), block cycler cover, storage box.

LightCycler® 480 Reagents and Assays

Product	Cat. No.	Pack Size
LightCycler® 480 SYBR Green I Master (2× concentrated)	04 707 516 001	5 × 1 ml (500 × 20 µl reactions)
	04 887 352 001	10 × 5 ml (5000 × 20 µl reactions)
LightCycler® 480 Probes Master (2× concentrated)	04 707 494 001	5 × 1 ml (500 × 20 µl reactions)
	04 887 301 001	10 × 5 ml (5000 × 20 µl reactions)
	04 902 343 001	1 × 50 ml (5000 × 20 µl reactions)
LightCycler® 480 Genotyping Master (5× concentrated)	04 707 524 001	4 × 384 µl (384 × 20 µl reactions)
LightCycler® 480 High Resolution Melting Master	04 909 631 001	5 × 1 ml (500 × 20 µl reactions)
LightCycler® 480 RNA Master Hydrolysis Probes	04 991 885 001	500 × 20 µl Reactions
LightCycler® 480 CYAN 500 Labeling Reagent	04 764 153 001	1 Vial
LightCycler® 480 Control Kit	04 710 924 001	1 Kit (3 control runs)
Transcriptor First Strand cDNA Synthesis Kit ¹⁾	04 379 012 001	1 Kit (50 reactions)
	04 896 866 001	1 Kit (100 reactions)
	04 897 030 001	1 Kit (200 reactions)
Universal ProbeLibrary Set, Human	04 683 633 001	1 Set ²⁾
Universal ProbeLibrary Extension Set	04 869 877 001	1 Set ²⁾
Universal ProbeLibrary Set, Human Reference Gene Assays	05 046 114 001	1 Set ²⁾
Universal ProbeLibrary Single Assays	For detailed information, visit www.universalprobelibrary.com	
RealTime ready Focus Panels	For detailed information, visit www.realtimeready.roche.com	
RealTime ready Cell Lysis Kit (5× concentrated)	05 943 523 001	5 × 1 ml (1,250 × 20 µl reactions)
	06 336 821 001	

¹⁾ For detailed information, visit www.roche-applied-science.com/pcr

²⁾ For detailed information, visit www.universalprobelibrary.com

Published by

Roche Diagnostics GmbH
Sandhofer Straße 116
68305 Mannheim
Germany

© 2012 Roche Diagnostics.
All rights reserved.

www.roche-applied-science.com

05237645001 ④ 1012